

STEP 1:

- 1) Connect bottom shelf(2) to left pier(5) and right pier(6) use D(flat washer) C(spring washer) B(bolt) and A(Allen wrench).
- 2) Connect top panel(1) to left pier(5) and right pier(6) use D(flat washer) C(spring washer) B(bolt) and A(Allen wrench).
- 3) Connect back panel(4) to top panel(1) and bottom panel(2) use D(flat washer) C(spring washer) B(bolt) and A(Allen wrench).

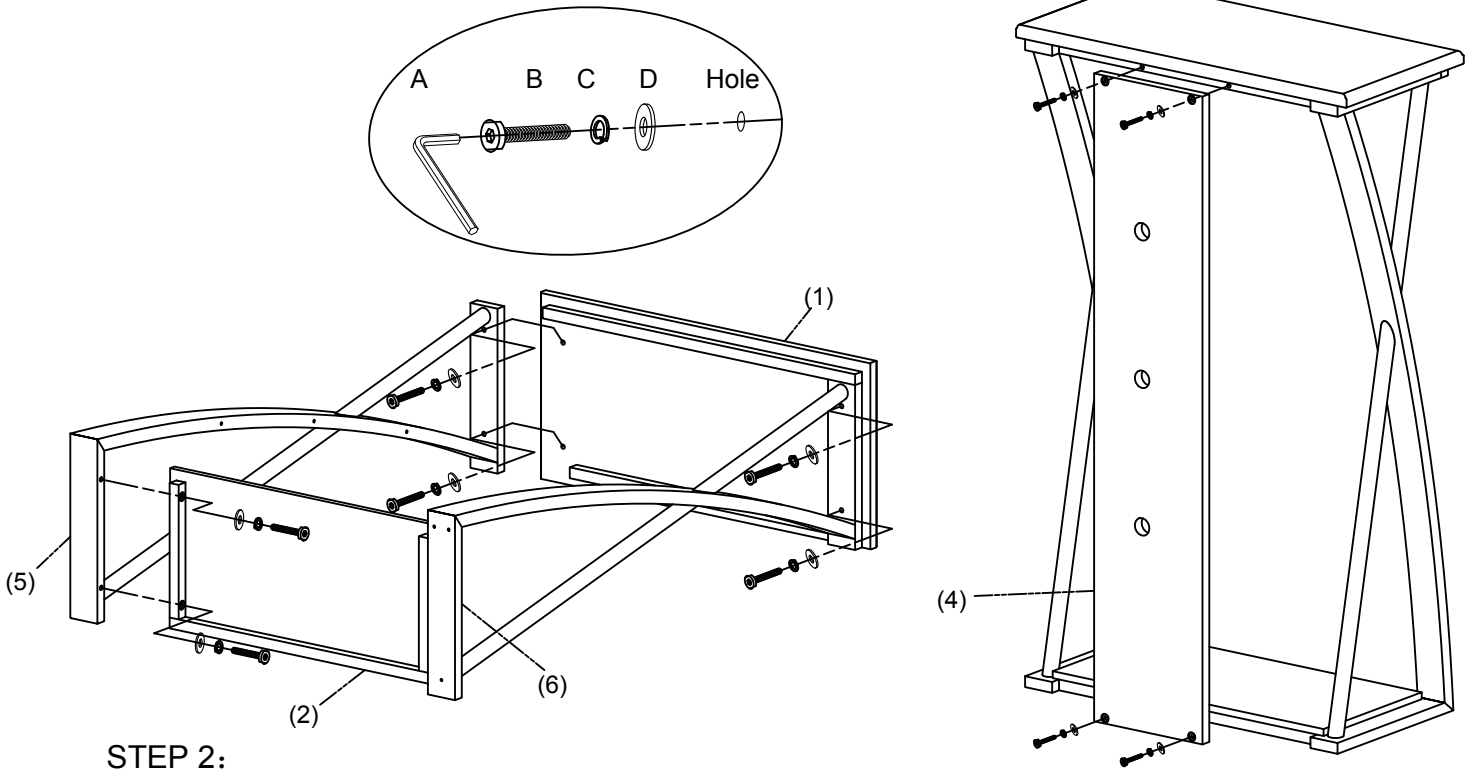

STEP 2:

- 1) Insert shelf pin(E) into left/right(5)/(6) and back panel(4) holes, then put glass shelf(3) on the shelf pin(E) tighten with spanner.

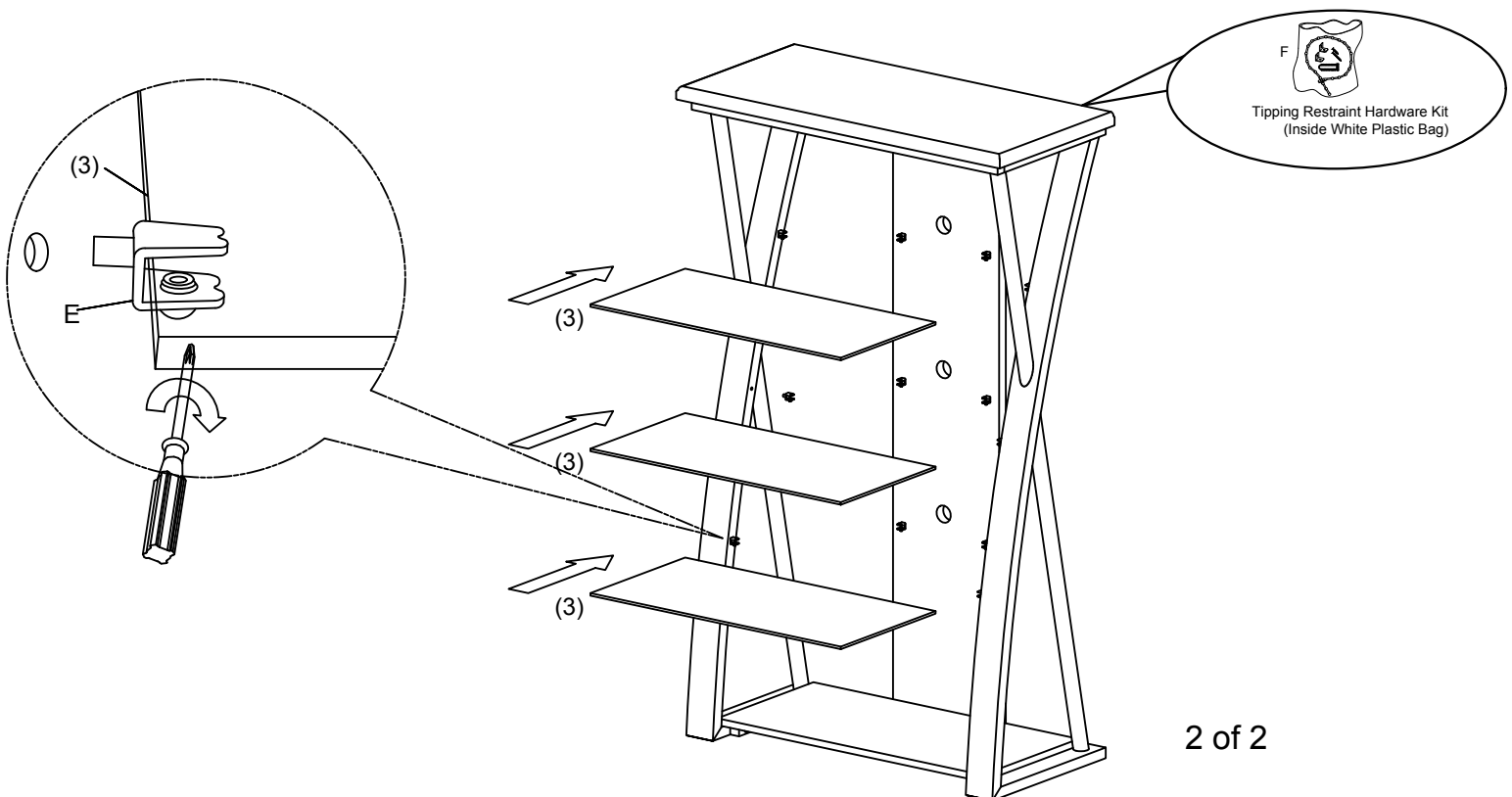





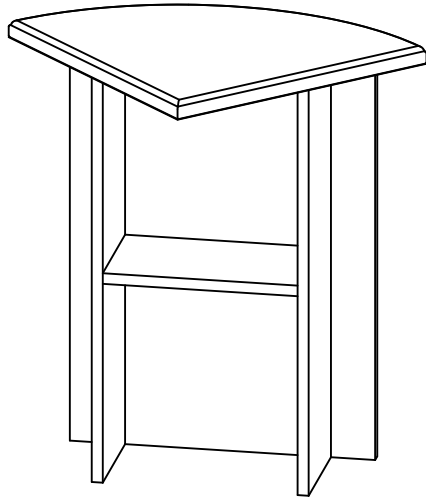



Assembly Instructions

*ZK-Z6030 Super Z Corner Desk



HARDWARE LIST

PART#	DESCRIPTION		QTY
A	Allen Wrench (5mm)		1pc
B	Bolt (5/16"x1")		5pcs
C	Bolt (5/16"x1-1/4")		4pcs
D	Spring Washer (5/16")		9pcs
E	Flat Washer (5/16"x16mm)		9pcs
F	Combiner (6.3x35mm)		2pcs
G	Combiner (15x11.5mm)		2pcs
H	Wood Plug (8x30mm)		2pcs

PLEASE NOTE:

- 1), BEFORE BEGINNING REVIEW THE PARTS LIST TO ASSURE THAT ALL ITEMS ARE PRESENT.
- 2), ASSEMBLE YOUR ITEM ON A SOFT FLAT SURFACE TO PREVENT SCRATCHING THE FINISH.

PARTS LIST

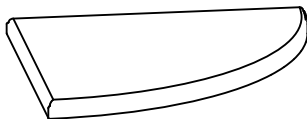

(1) DESK TOP

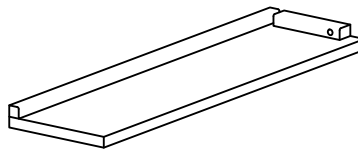

(2) RIGHT PIER

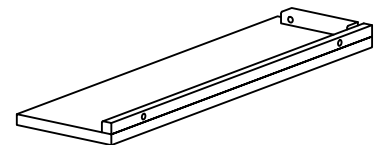

(3) LEFT PIER

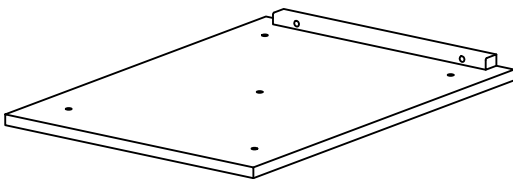

(4) BACK PANEL

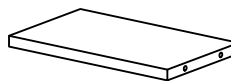

(5) SHELF

STEP 1:

- 1) Put the combiner(F) in the right pier(2) and left pier(3) tighten with spanner.
- 2) Put the wood plug(H) in the shelf(5), then connect shelf(5) to right pier(2) and left pier(3). Use combiner(G) to fix the combiner(F) tighten with spanner.

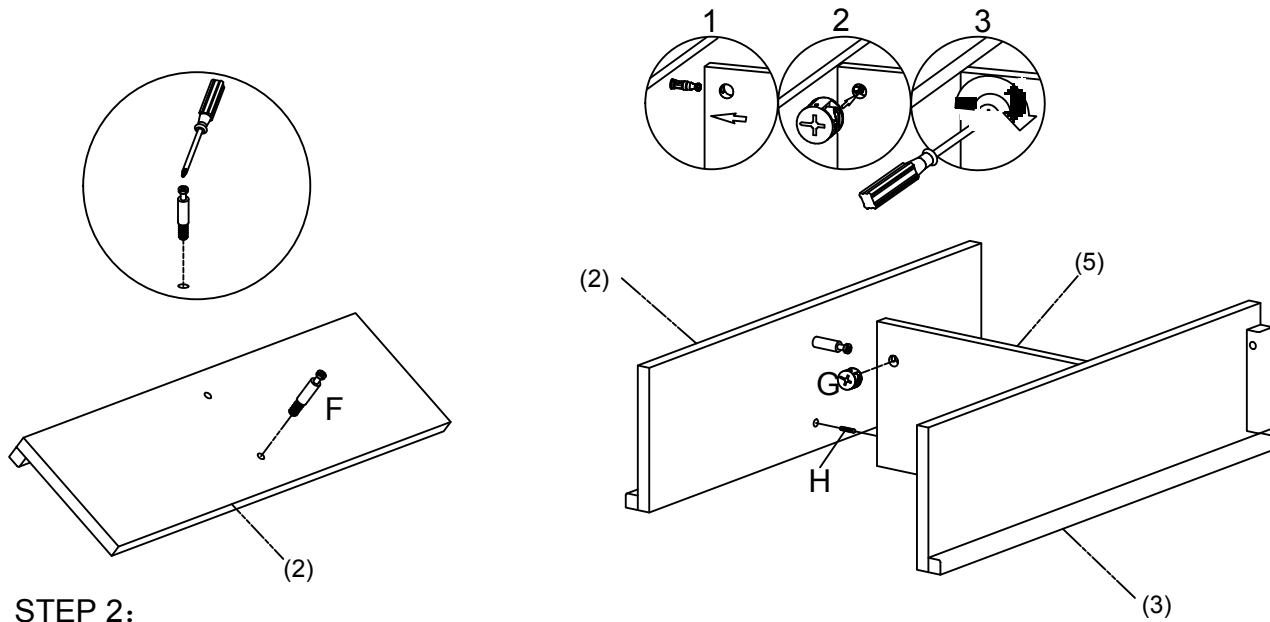

STEP 2:

- 1) Connect back panel(4) to left pier(3) and right pier(2) use E(flat washer) D(spring washer) B(bolt) and A(Allen wrench).
- 2) Connect desk top(1) to back panel(4) and left pier(3) and right pier(2) use E(flat washer) D(spring washer) C(bolt) and A(Allen wrench).

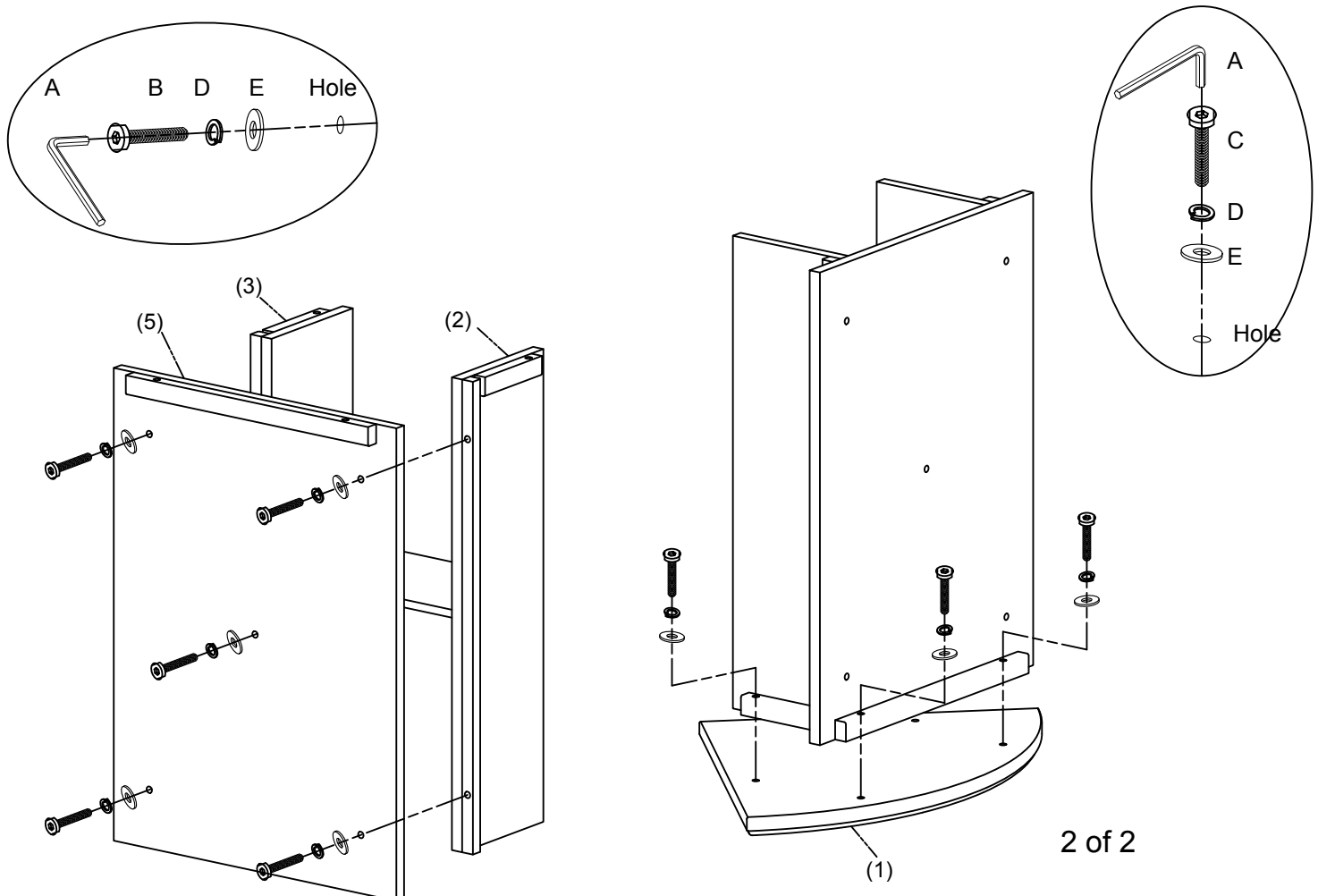







2 of 2

Thanks for choosing legends furniture!

Assembly Instructions

*ZK-Z6030 Super Z Bookcase

HARDWARE LIST

PART#	DESCRIPTION		QTY
A	Allen Wrench (5mm)		1pc
B	Bolt (5/16"x1-1/2")		12pcs
C	Spring Washer (5/16")		12pcs
D	Flat Washer (5/16"x16mm)		12pcs
E	Shelf Pin		12pcs
F	Tipping Restraint Hardware Kit		1pc

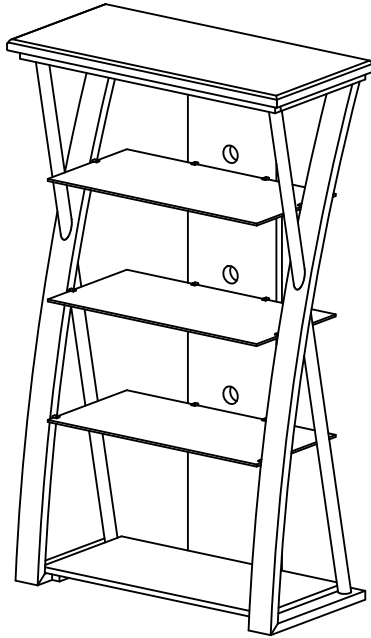

PLEASE NOTE:

- 1), BEFORE BEGINNING REVIEW THE PARTS LIST TO ASSURE THAT ALL ITEMS ARE PRESENT.
- 2), ASSEMBLE YOUR ITEM ON A SOFT FLAT SURFACE TO PREVENT SCRATCHING THE FINISH.

PARTS LIST

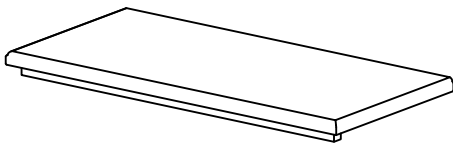

(1) TOP PANEL

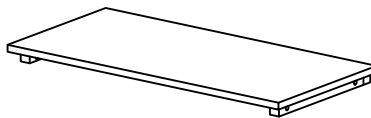

(2) BOTTOM PANEL



(3) GLASS SHELF

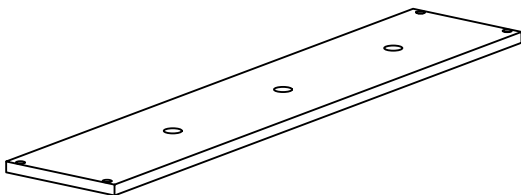

(4) BACK PANEL

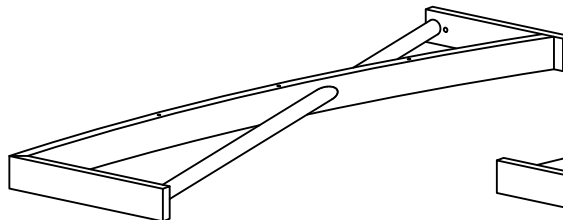

(5) LEFT PIER

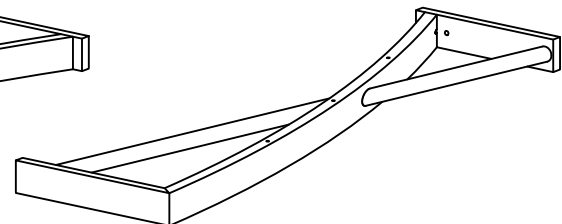

(6) RIGHT PIER







Super Z Assembly Instructions

ZK-Z6020 - Writing Desk



HARDWARE LIST

PART#	DESCRIPTION		QTY
A	Allen Wrench		1 PC
B	Bolt		8 PCS
C	Bolt		2 PCS
D	Lock Washer		10 PCS
E	Washer		10 PCS

PLEASE NOTE:

1. BEFORE BEGINNING, REVIEW THE PARTS LIST TO ASSURE THAT ALL ITEMS ARE PRESENT.
2. ASSEMBLE YOUR ITEM ON A SOFT, FLAT SURFACE TO PREVENT SCRATCHING THE FINISH.

PARTS LIST

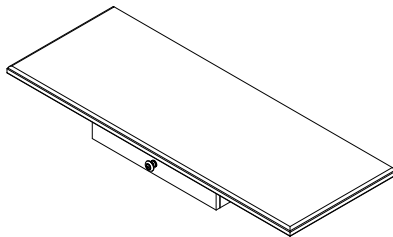

(1) DESK TOP

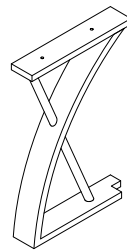

(2) RIGHT PIER

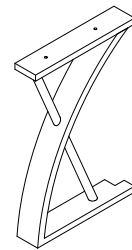

(3) LEFT PIER

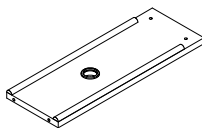

(4) BACK PANEL

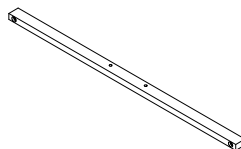

(5) BOTTOM RAIL

STEP 1

1. Place desk top (1) face down on a smooth, flat surface.
2. Connect right pier (2) & left pier (3) to desk top using E (flat washer), D (lock washer), B (bolt) & A (wrench).
3. Connect back panel (4) to desk top using E (flat washer), D (lock washer), B (bolt) and A (wrench).

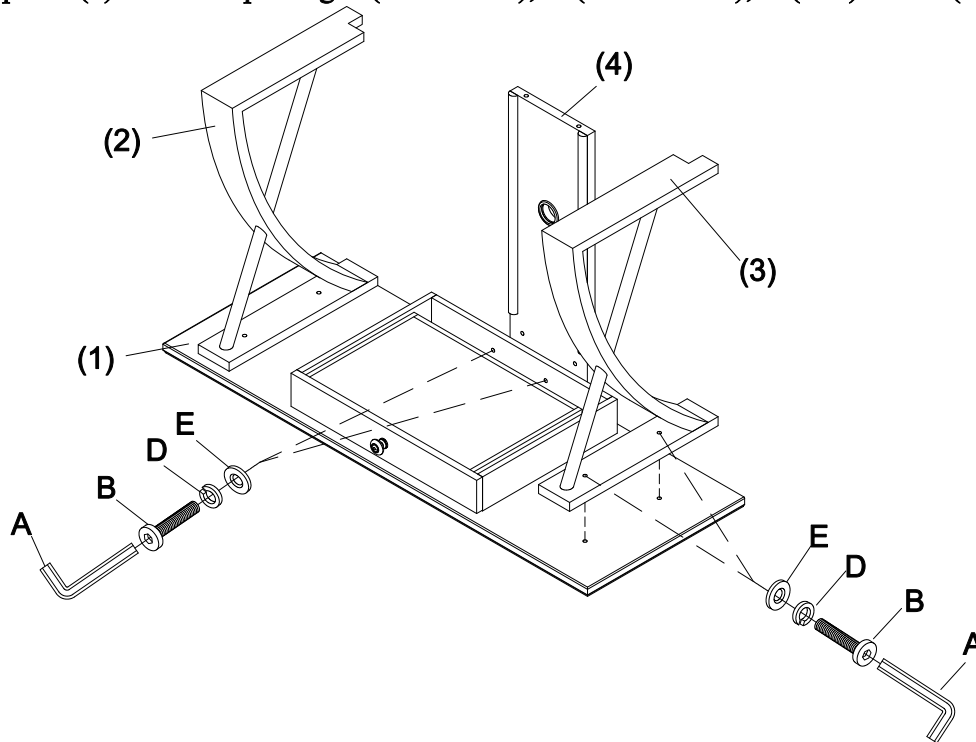

STEP 2

1. Connect bottom rail (5) to left and right pier using E (flat washer), D (lock washer), C (bolt), and A (wrench).
2. Connect bottom rail (5) to back panel (4) using E (flat washer), D (lock washer), B (bolt), and A (wrench).

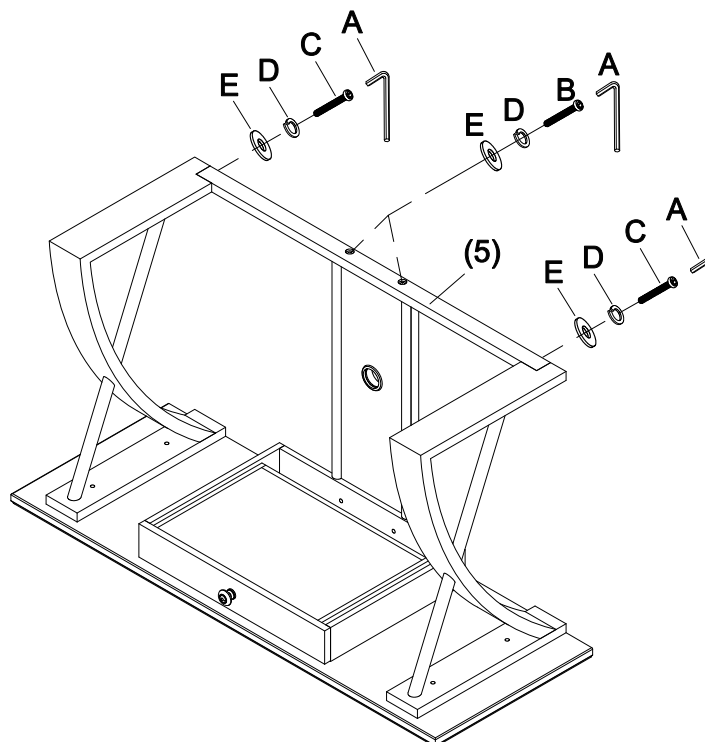

Thank you for choosing Legends Furniture!